



# Asset-Trade

Assessment & Sale of Used Assets

Ref. Nr.: 829-07240122



## Overview and Technical Data:

**BÖHMER Maschinenbau - HSB turbo-Control  
Akustikwuchttechnik**

**BÖHMER**

**Böhmer**  
Maschinenbau

Baujahr: Jan. 2009



## Description:

### **Gebrauchte BÖHMER Akustikprüfstand & Turbo-Control Auswuchtmaschine**

Auswuchtmaschine für Rotoren - Turbolader Rumpfungruppe

Technische Daten:

Werkstückgewicht 4 kg

Werkstücklänge 200 mm

dia. auf der kompletten Länge 200 mm

Steuerung Böhmer Turbo Control

Elektrik - Spannung / Frequenz 400/50 V / Hz

Anschlussleistung 12 kVA

Abmessungen 2,6 x 1,5 x 2,6 m

Akustischer Prüfstand zum Prüfen und Auswuchten des Turboladerrumpfes

Gruppen.

- Chip-Extraktion
- Ausrichtungseinheit
- Greifer



- Fräseinheit mit Druckluft-Frässpindel

Weitere Details aus Anfrage

---

## **Akustikwuchttechnik für Turbolader**

Mittels der Akustikwuchttechnik können hoch frequente Bauteile, wie z.B. Turbolader, sehr fein ausgewuchtet werden. Das Auswuchten von Turboladern für Automobile ist nötig, da Körper, welche um eine Achse rotieren, eine gewisse Unwucht mit sich bringen. Dies äussert sich in Form von Schwingungen, welche letztendlich zu einem erhöhtem Materialverschleiß und Leistungseinbußen führen würden.

Das Auswuchten der Turbolader erreicht man, indem man an bestimmten Stellen etwas Material abträgt. Da sich die Toleranzen in sehr kleinen Bereichen bewegen, bedarf es entsprechender Vorrichtungen. Der hier gezeigte Akustikprüfstand stellt ein solches Gerät dar.



## Technical Data:

### Technical Data:

Steuerung: CNC

### Dimensions and Weight:

Höhe: 2.285 mm

Länge: 2.608 mm

Breite: 1.114 mm

Gewicht: 3.700 kg

### Buyer Information:

Zustand: Sehr guten Zustand

Verfügbarkeit: Auf Anfrage

Verkauft als:

EXW (ab Werk - Incoterm)

MwSt.: 19 %

Standort: Deutschland



## Images:

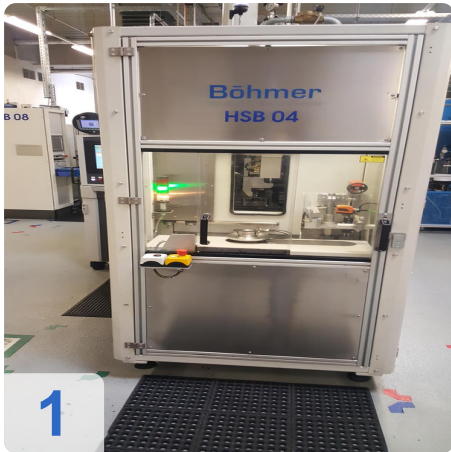



A

e

ssets

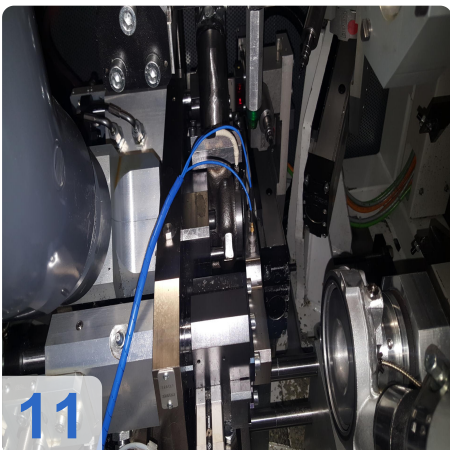
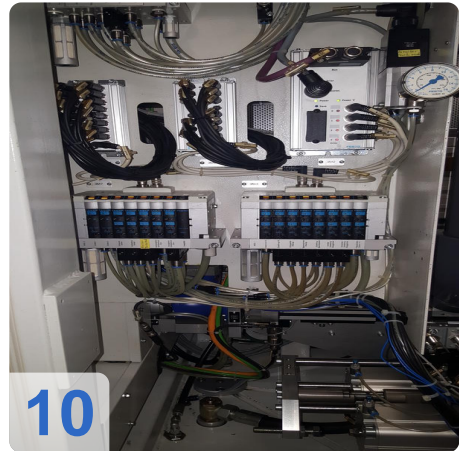
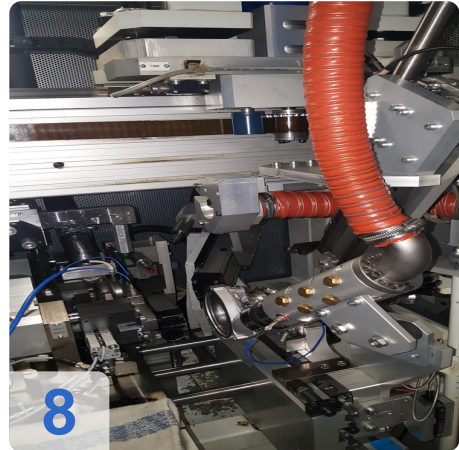
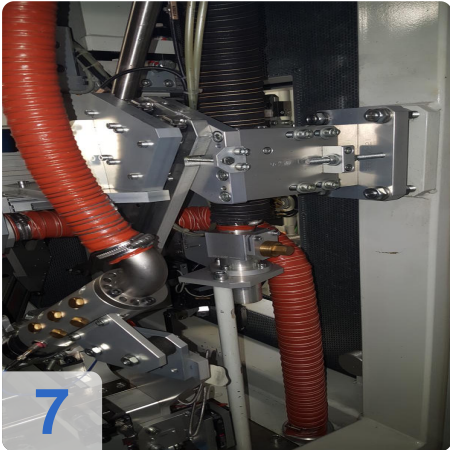
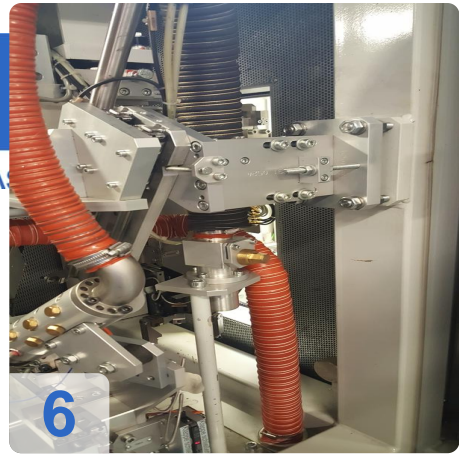



Assets

e

Assets

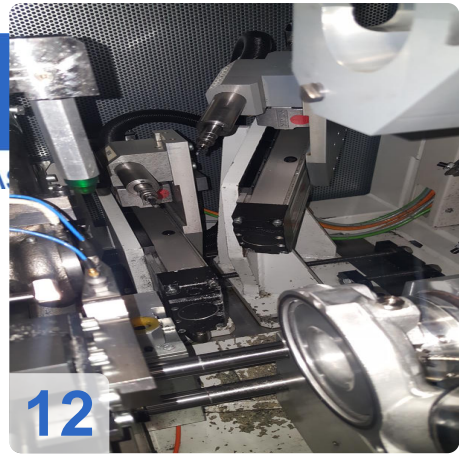

12



13



14



15

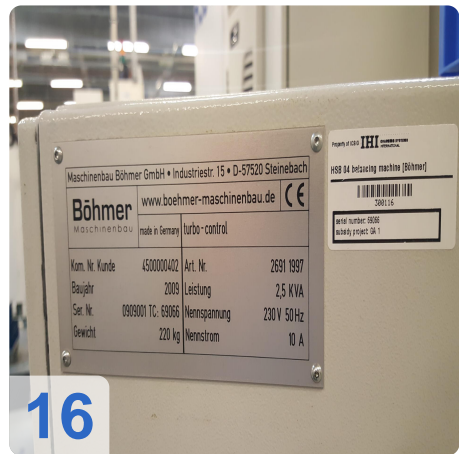

16



17



A

e

Assets

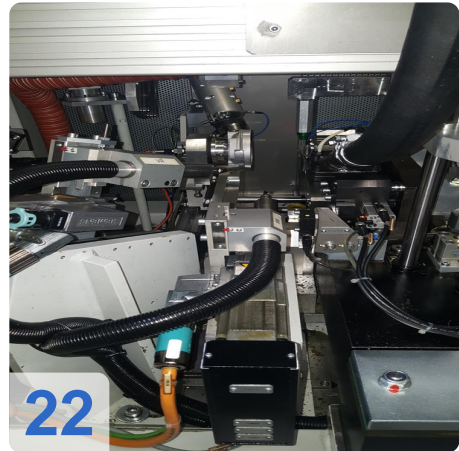
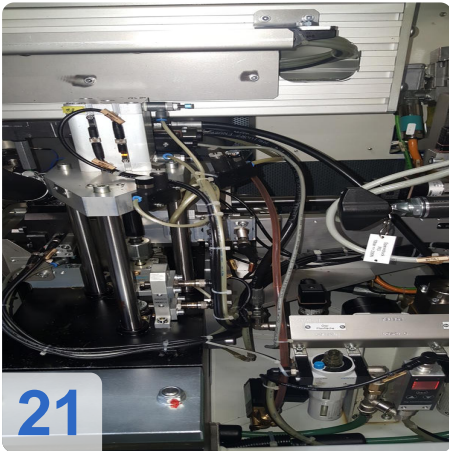





As

e

Assets

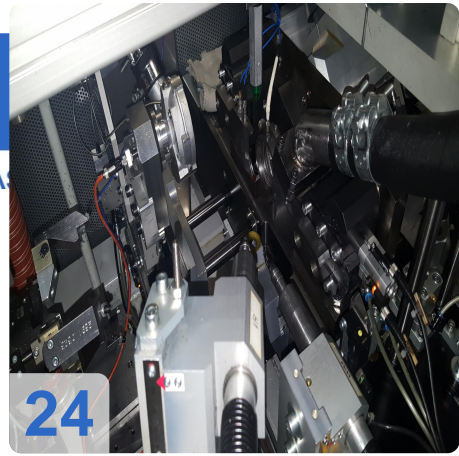

24



25

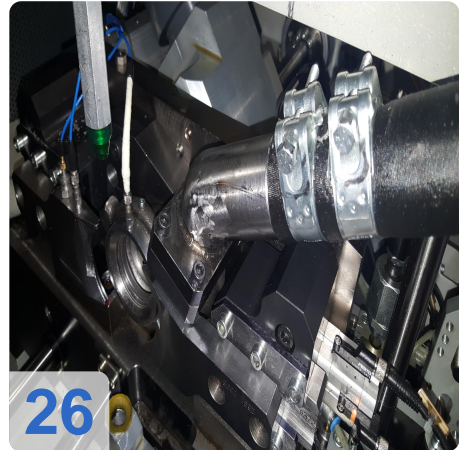

26



27

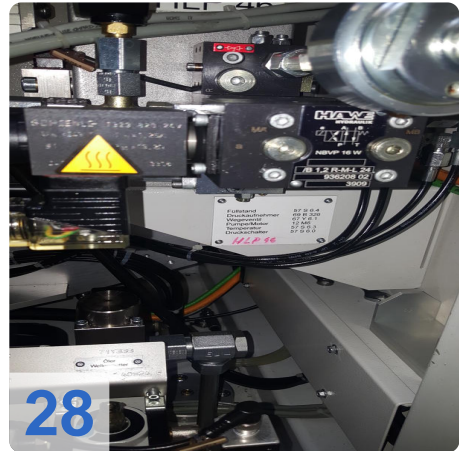

28



29



As

e

Assets

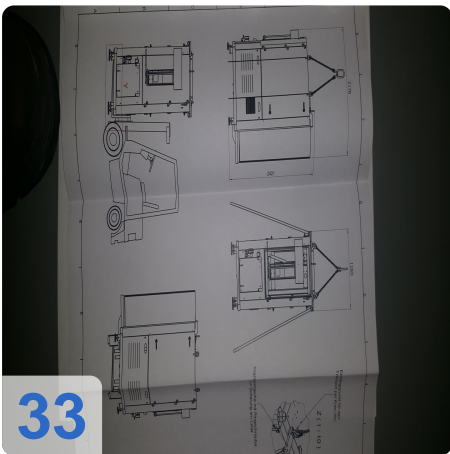
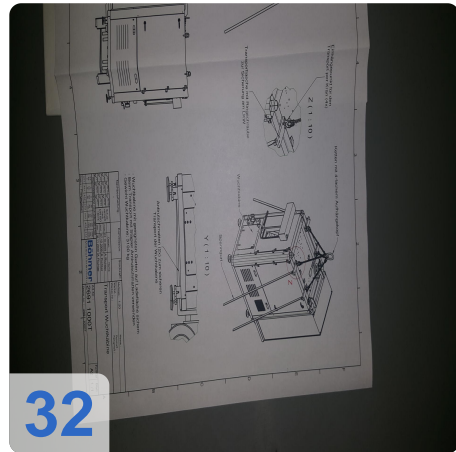
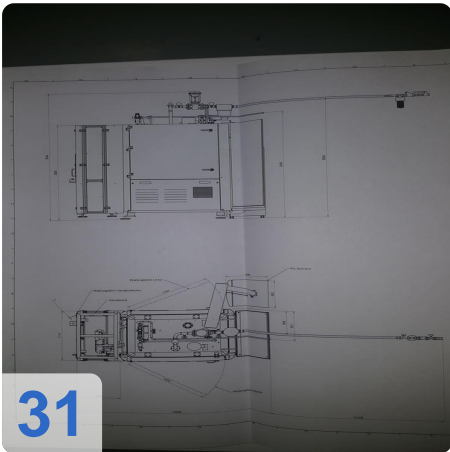
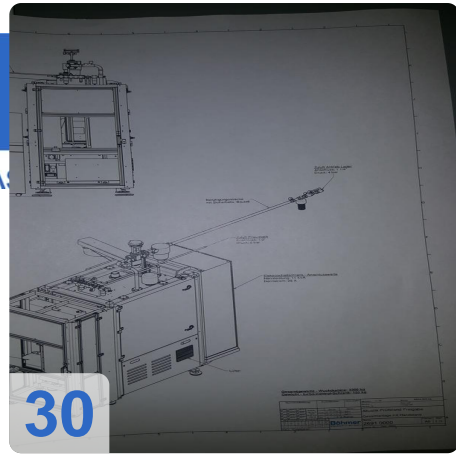



# Asset-Trade

Assessment & Sale of Used Assets



**Asset-Trade**

**Bewertung & Vermarktung von  
Industrieanlagen weltweit**

**Am Sonnenhof 16**

**47800 Krefeld**

**Deutschland**

**Tel.: +49 2151 32500 33**