



Asset-Trade

Assessment & Sale of Used Assets

Ref. No.: 126-07011546

Overview and Technical Data:

**KRONES - Complete KRONES RBG bottling
Line Beer, Softdrinks 60.000 l**

KRONES



Year of Build: Jan 1987



Description:

Complete KRONES/KHS/KETTNER RBG bottling Line Beer, Softdrinks

- Capacity 60.000 Bottles
- Bottle Size EURO 0,5l - Glass

Everything from :

- Unpacker
- Depalletizer
- H&K Bottle washer
- KHS bottle inspector
- KRONES Type VK 2V CF 144 Filler & Labeller
- KETTNER Palletizer
- Packer
- APV Heat exchanger

More Information to follow



Technical Data:

Technical Data:

Control: CNC

Buyer Information:

Condition: Normal wear

Available: February

Sold as:

EXW (Ex Works - Incoterm)

VAT: 19 %

Buyers Premium: 15 %

Location: Germany



Images:





A

e

Assets

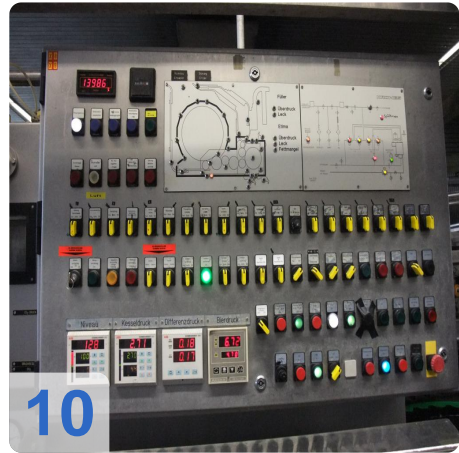
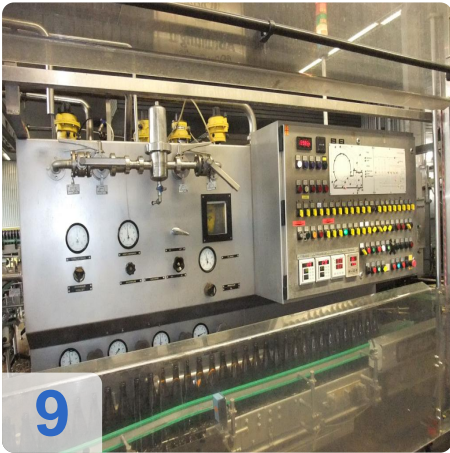



AS

e

Assets





As

e

ssets

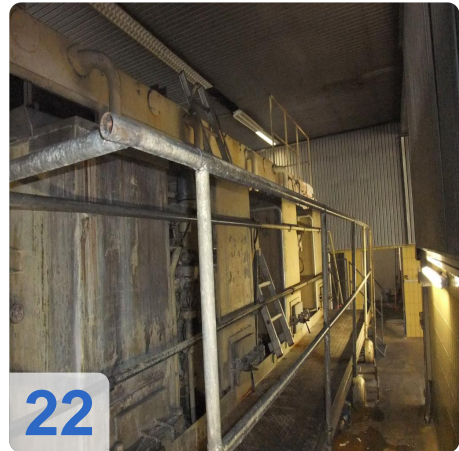



As

e

ssets

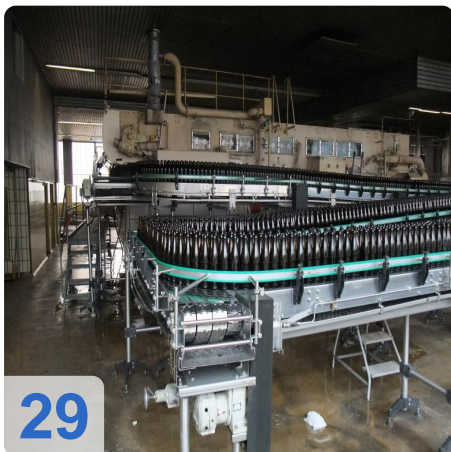
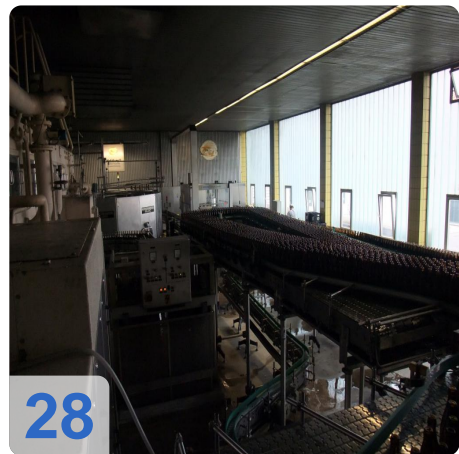
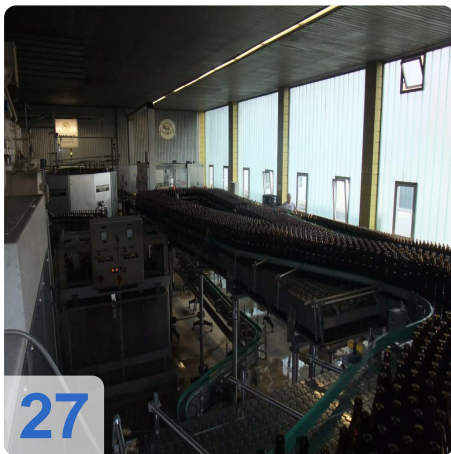
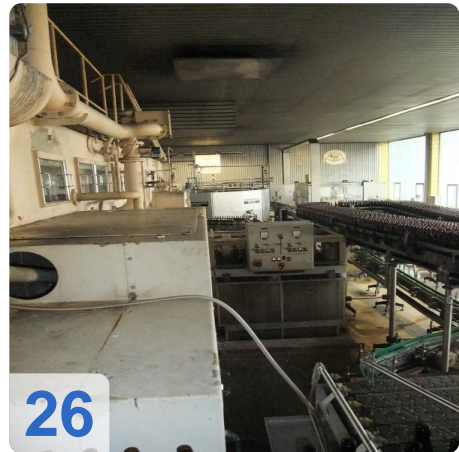
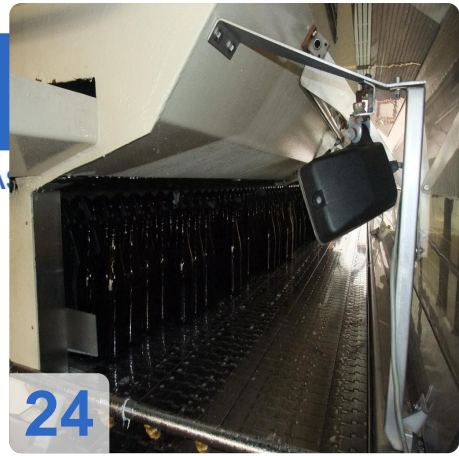



A

e

ssets

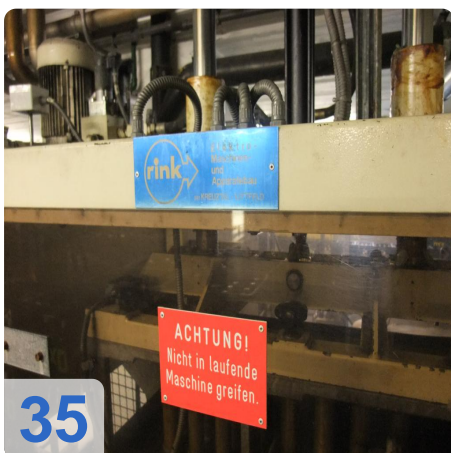
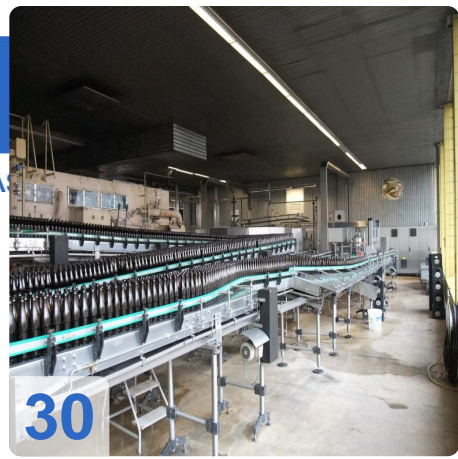



AS

e

Assets



36



37



38



39

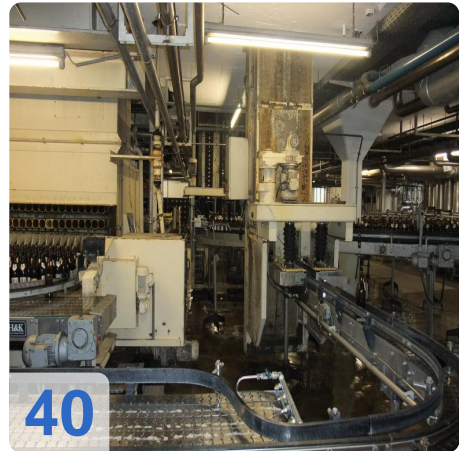

40



41



A

e

Assets

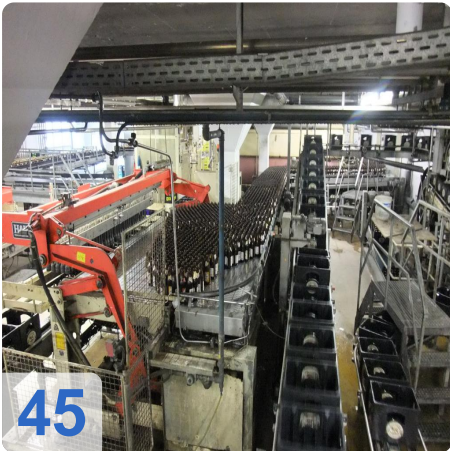
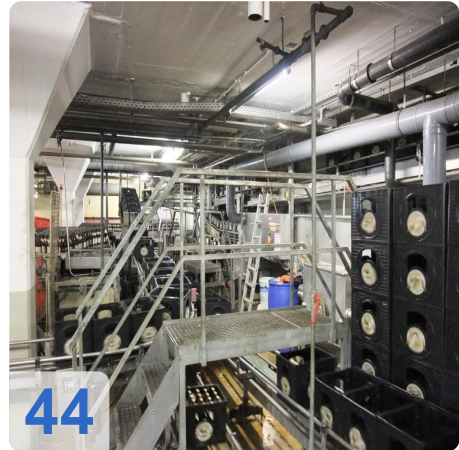
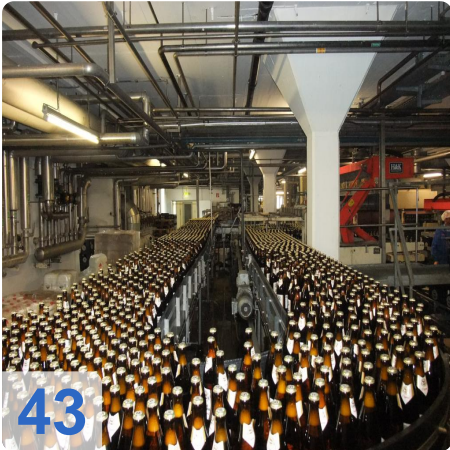
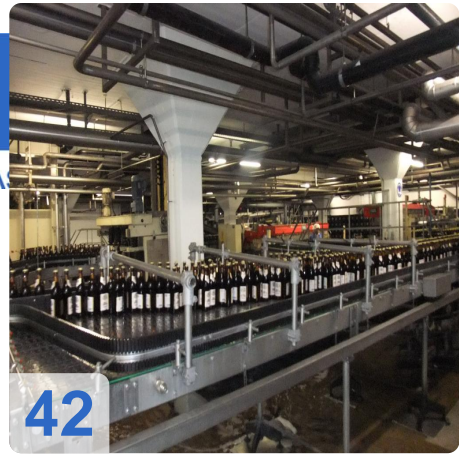



AS

e

Assets



48



49



50



51



52



53

EMPAC EMPAC AG
Verpackungsmaschinen
CH 8820 WÄRDEN
Schweiz, Schweiz
TYP 1500-4 SERIE-NR.
BAUJAHR 1987



A

e

ssets



54



55

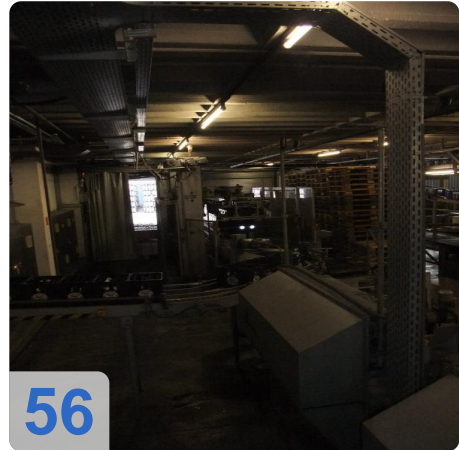

56



57

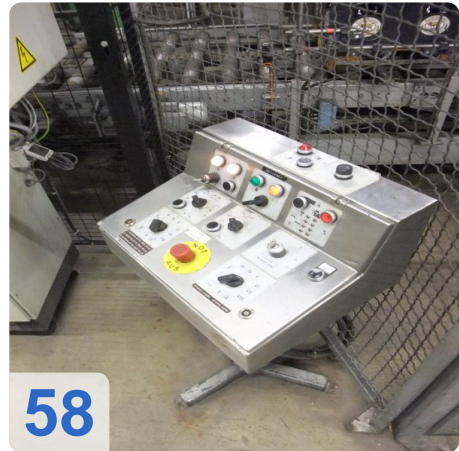

58

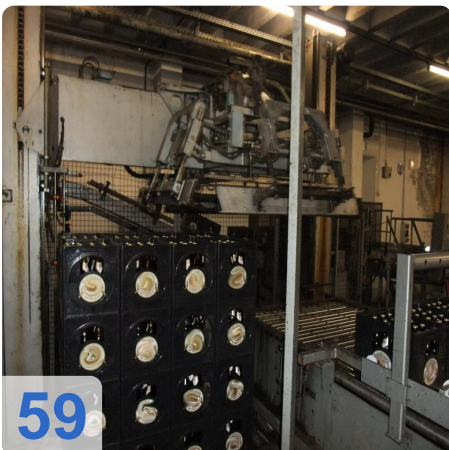

59



As

e

ssets

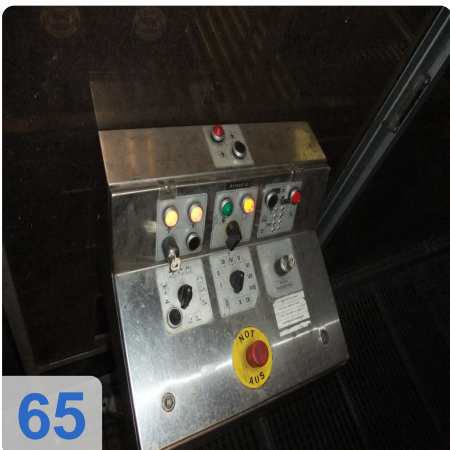
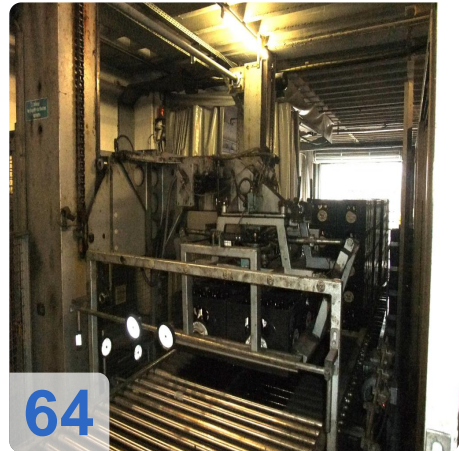
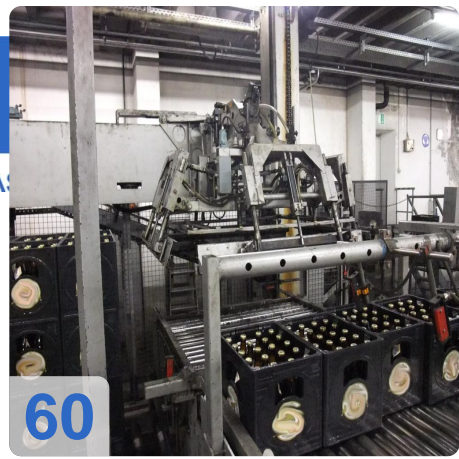



As

e

Assets

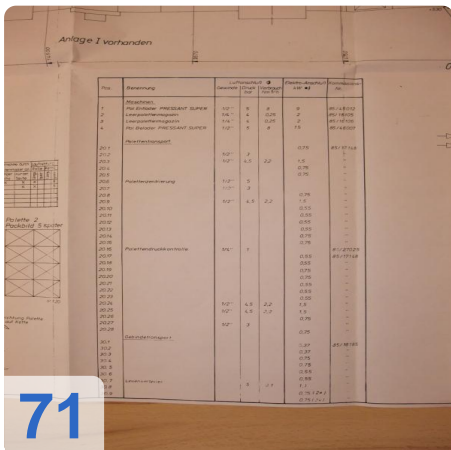
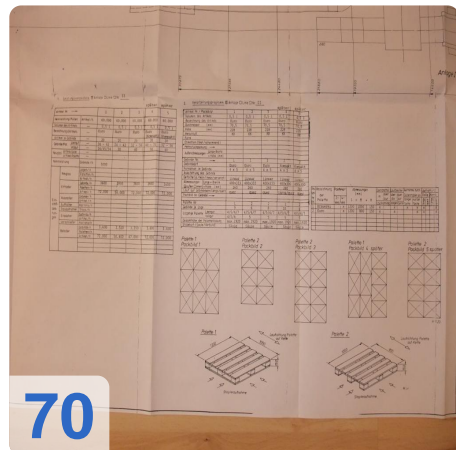
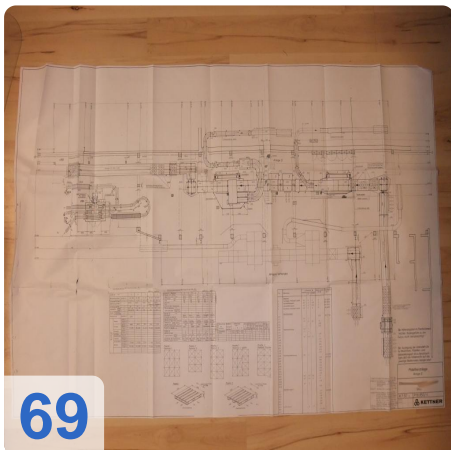
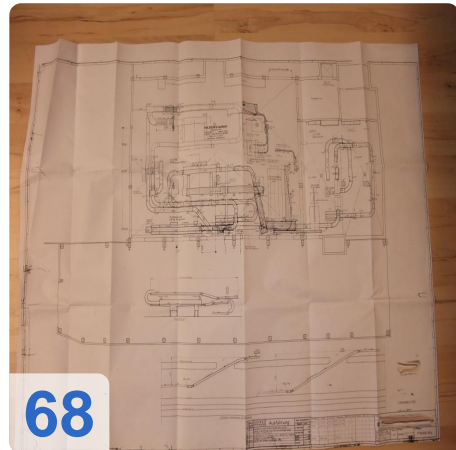
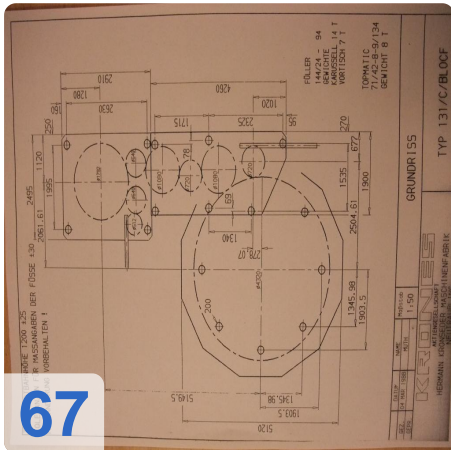
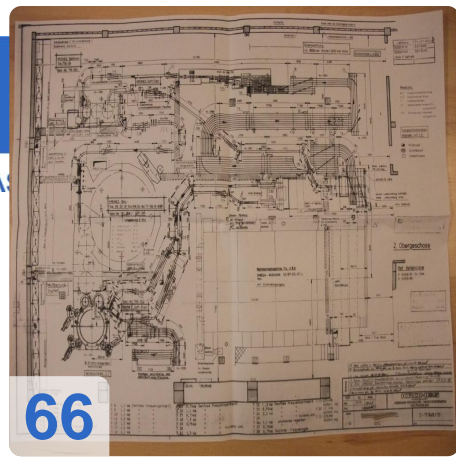



As

e

assets

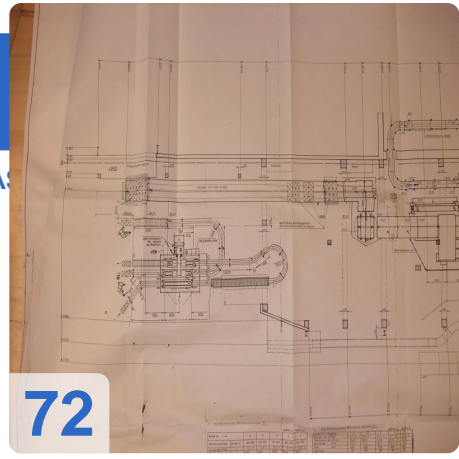

72

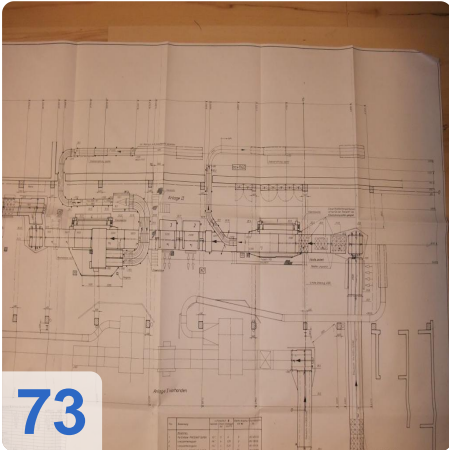

73

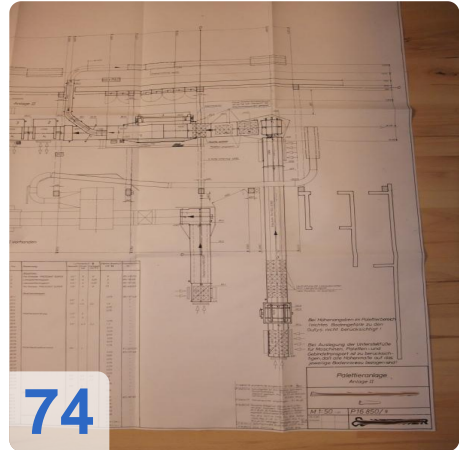

74

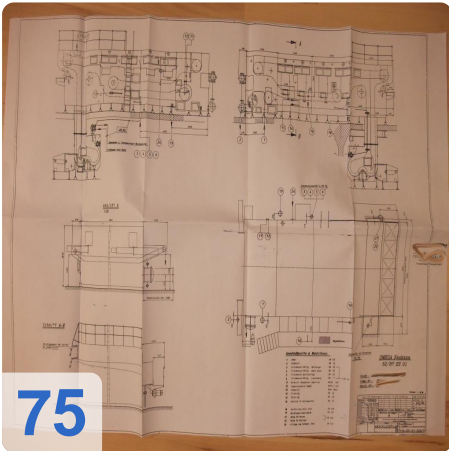

75

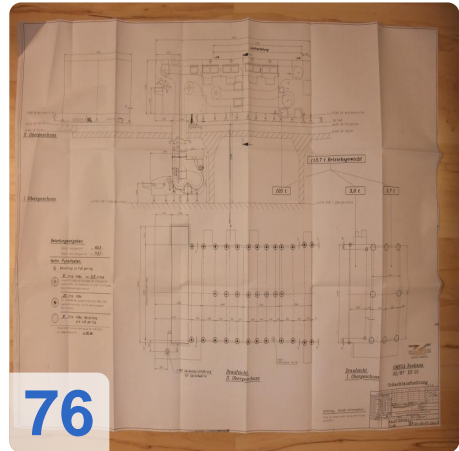

76



Asset-Trade

Assessment & Sale of Used Assets

QR Code for <https://www.asset-trade.de/en/print/pdf/node/659?lang=en>

Asset-Trade

**Assessment and Sale of Used Assets world
wide**

Am Sonnenhof 16

47800 Krefeld

Germany

Tel.: +49 2151 32500 33