



# Asset-Trade

Assessment & Sale of Used Assets

Ref. No.: 829-07240122



## Overview and Technical Data:

**BÖHMER Maschinenbau Turbo control  
Acoustic Balancing Machine**

**BÖHMER**

**Böhmer**  
Maschinenbau

Year of Build: Jan 2009



## Description:

### Used BÖHMER HSB - Acoustic Test Stand & Turbo-Control Balancing Machine

Balancing machine for rotors for Turbocharger group

Technical data:

- workpiece weight 4 kg
- workpiece length 200 mm
- dia. on complete length 200 mm
- Control Böhmer Turbo Control
- electrics - voltage/frequency 400 / 50 V/Hz
- connected load 12 kVA
- dimensions 2,6 x x 1,5 x 2,6 m

Acoustical test stand for checking and then balancing turbocharger fuselage

groups.

- Chip extraction
- Alignment unit
- grippers
- Milling unit with compressed air milling spindle

More details on request

---

#### Acoustic load balancing for turbochargers:

By means of the acoustic balancing technique, high-frequency components, e.g. Turbocharger, can be very finely balanced. The balancing of turbochargers for automobiles is necessary because bodies that rotate about an axis cause a certain imbalance. This manifests itself in the form of vibrations, which ultimately lead to increased material wear



and losses in performance.

Balancing the turbochargers is achieved by removing some material at certain points. Since the tolerances move in very small regions, corresponding devices are required. The acoustics test stand shown here represents such a device.



## Technical Data:

### Technical Data:

Control: CNC

### Dimensions and Weight:

Height: 2.285 mm

Length: 2.608 mm

Width: 1.114 mm

Weight: 3.700 kg

### Buyer Information:

Condition: Very good condition

Available: On Request

Sold as:

EXW (Ex Works - Incoterm)

VAT: 19 %

Location: Germany



## Images:

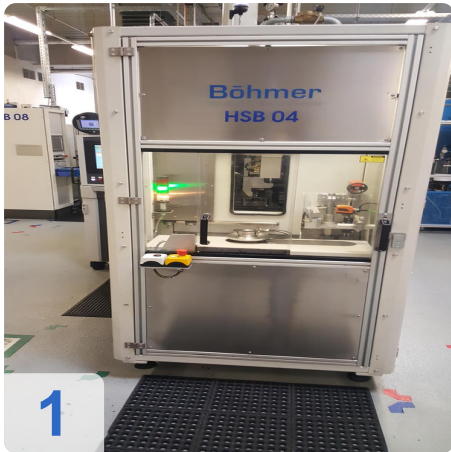



A

e

ssets

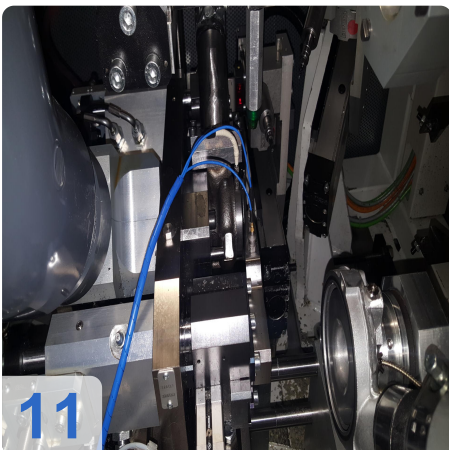
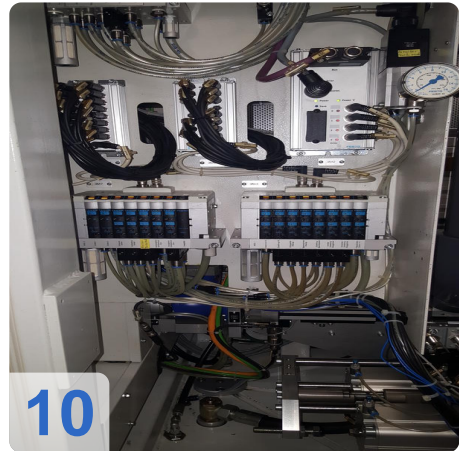
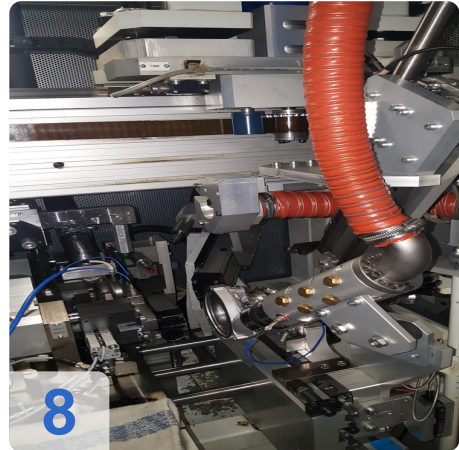
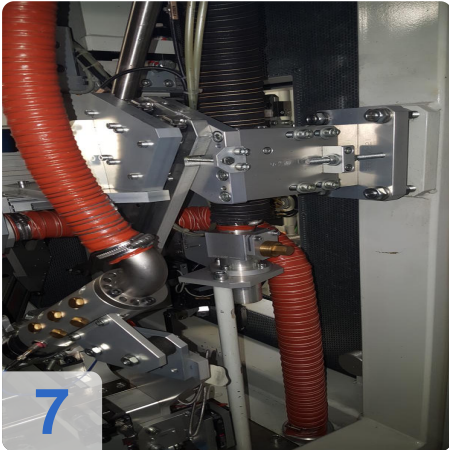
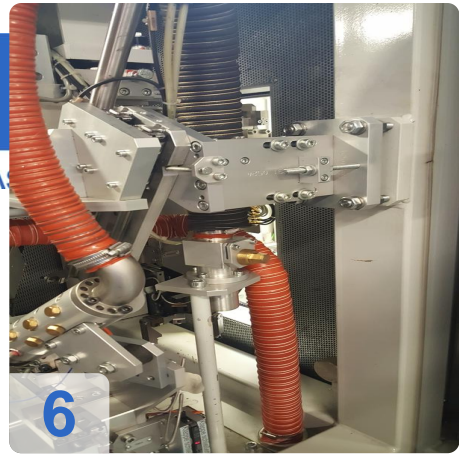



Assets

e

Assets

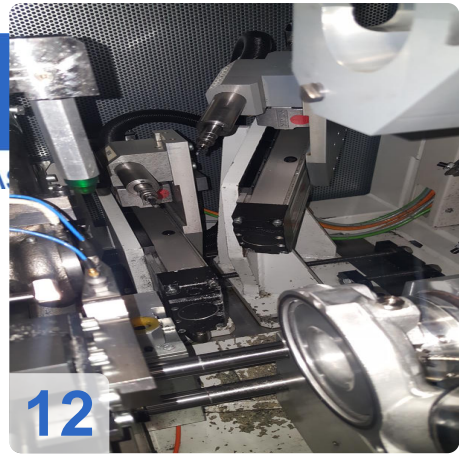

12



13



14



15

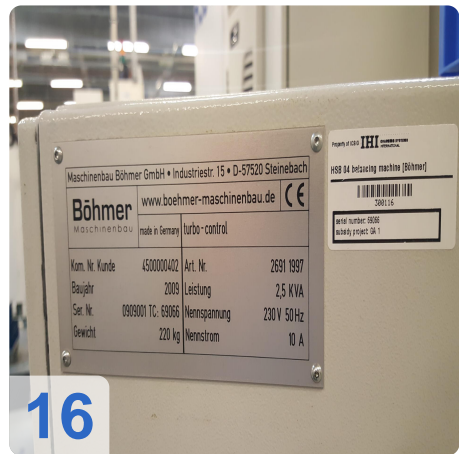

16



17



Asset-Trade

e

Assets

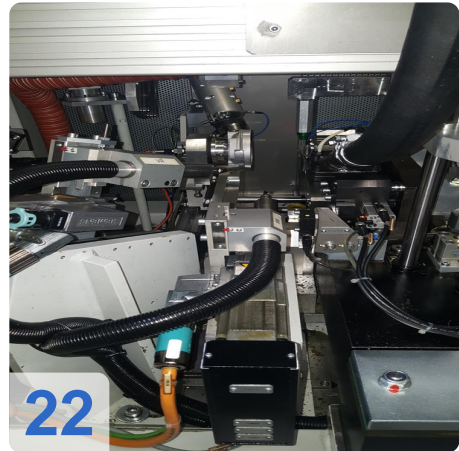
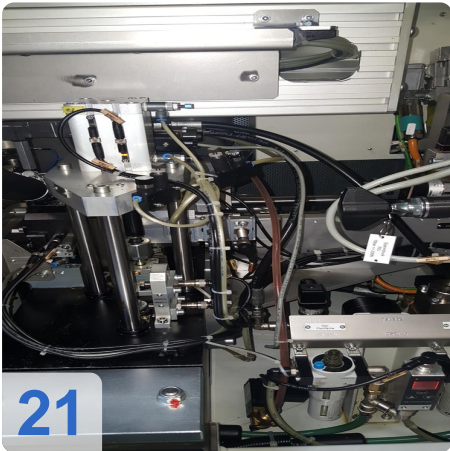





As

e

Assets

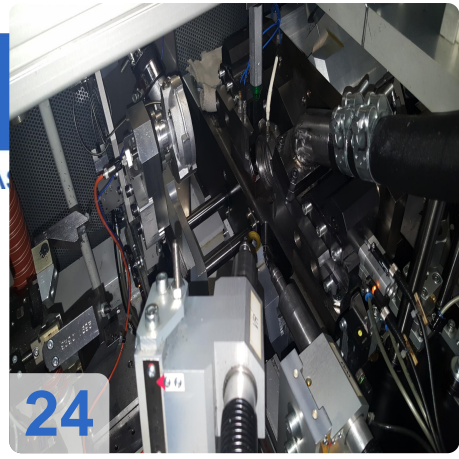

24



25

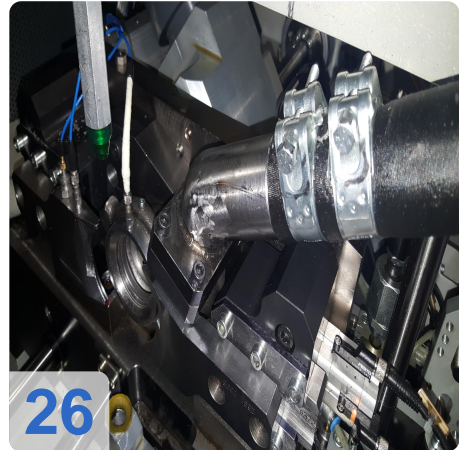

26



27

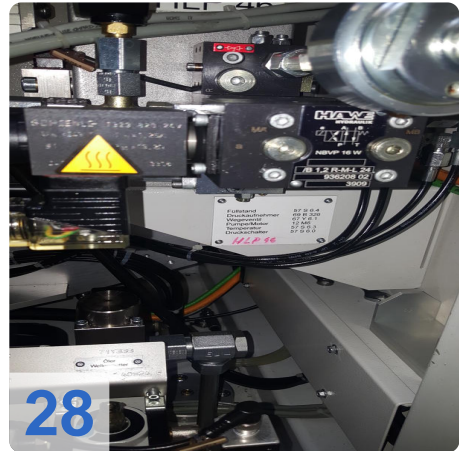

28



29



As

e

Assets

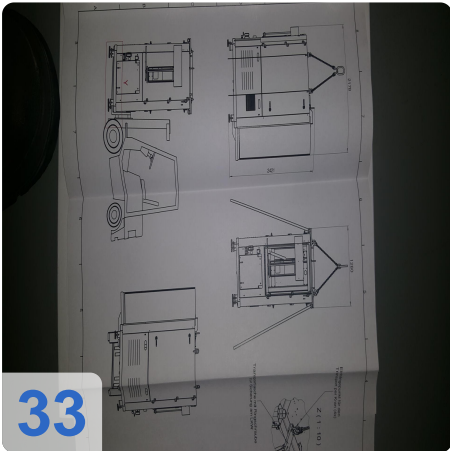
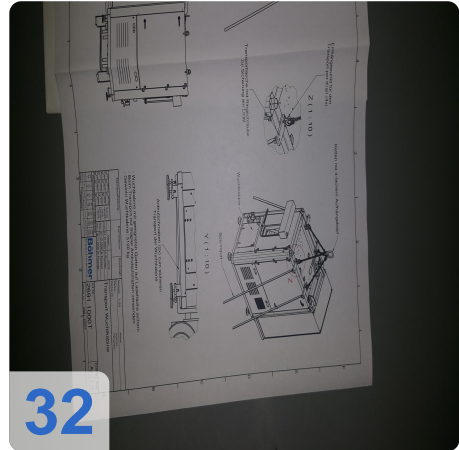
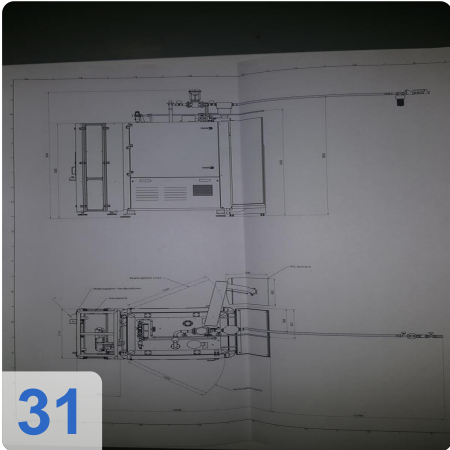
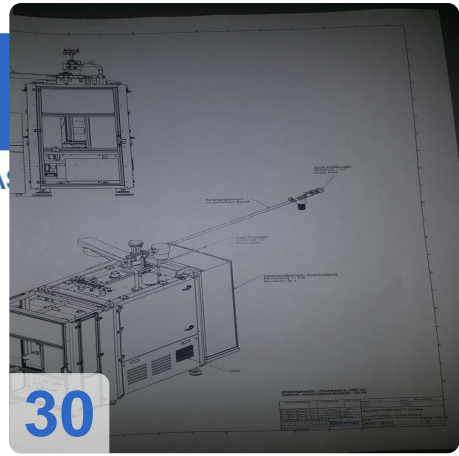



# Asset-Trade

Assessment & Sale of Used Assets

QR Code for <https://www.asset-trade.de/en/print/pdf/node/5713?la>

**Asset-Trade**

**Assessment and Sale of Used Assets world  
wide**

**Am Sonnenhof 16**

**47800 Krefeld**

**Germany**

**Tel.: +49 2151 32500 33**